

Data Sheet



Article number: 586350417

Description: Ball Valve 350.417, G 3" - G 3"
Thread/Thread

Measures

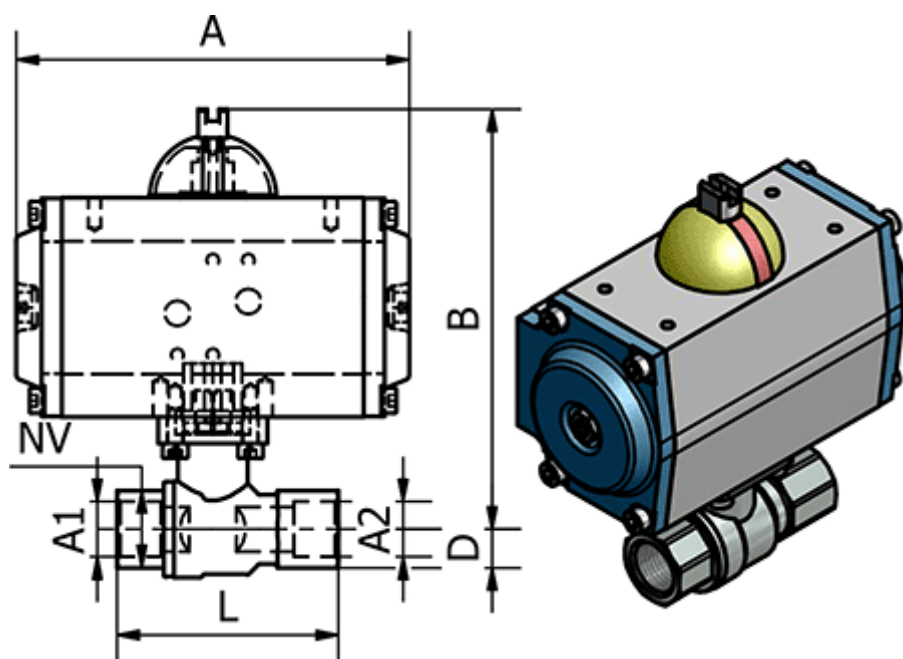

A	= 209
B	= 242
Connecting A1	= G 3"
Connecting A2	= G 3"
D	= 68
L	= 182
Max. Operating Pressure	= 16 bar
NV	= 98